

ABRIGO DE EMERGÊNCIA - Instruções para instalação de lona

EXEMPLOS

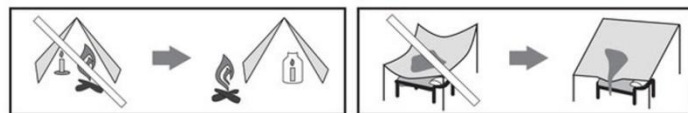
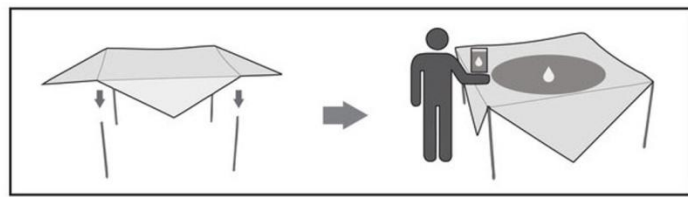
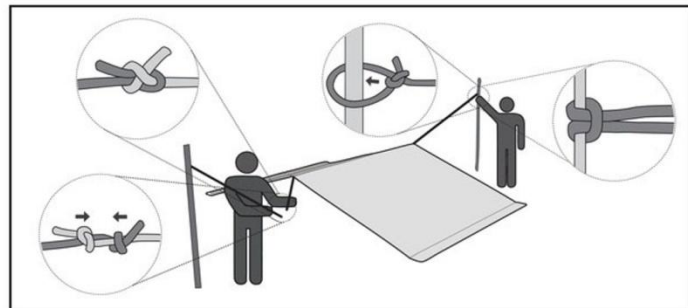
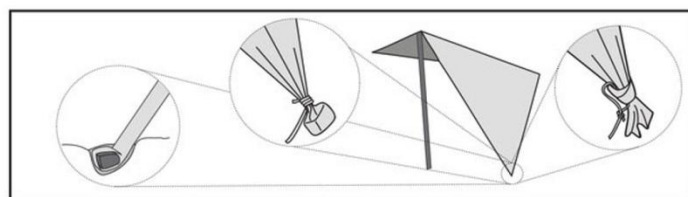
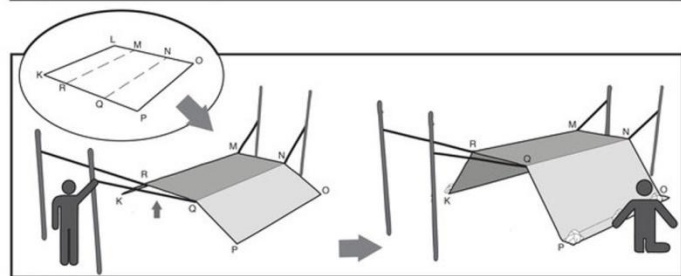
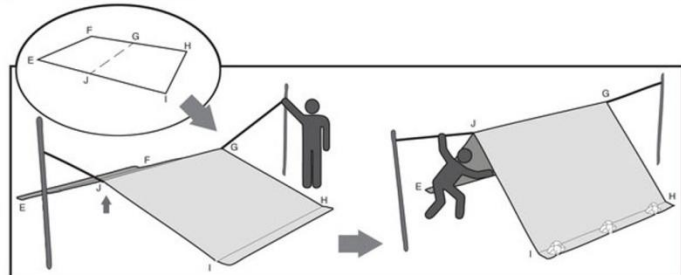
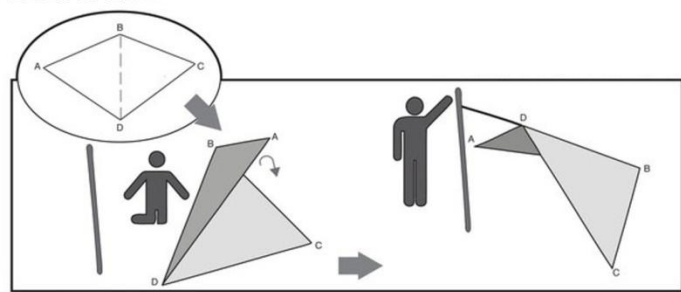

FIXAÇÃO DE LONAS AO SOLO

<p>Os piquetes vão rasgar a lona</p>	<p>Enterre a lona em uma trincheira</p>	<p>Enrole a lona nas rochas Então enterre em uma trincheira</p>

FIXAÇÃO DE LONAS A CORDA

<p>Furo não reforçado irá rasgar</p>	<p>Use anilhas se eles são de boa qualidade</p>	<p>A corda grossa com um pequeno corte nas faixas de reforço é forte</p>

<p>Dobrar a lona sobre uma pedra e amarrar com uma corda é forte</p>	<p>Um nó na lona com uma corda através do nó é forte</p>	<p>Cuidado com o fogo!</p>

FIXAÇÃO DE LONAS EM MADEIRA

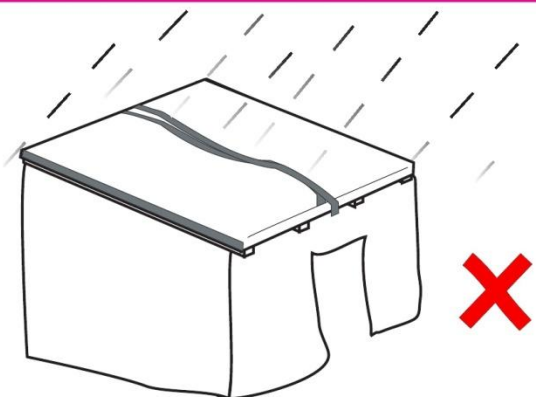

Não deixe as poças formarem

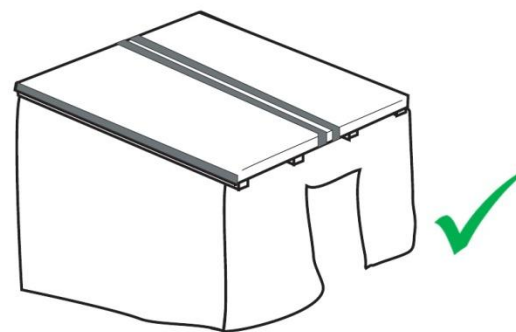

Puxe as lonas apertadas

Pregue as lonas em torno de uma borda de força
Prego através das faixas de reforço, se houver algum

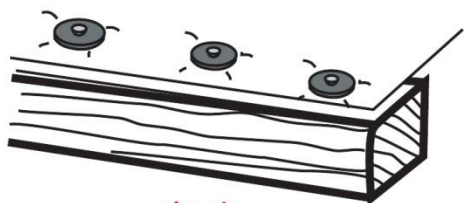

NÃO divida a madeira com os pregos

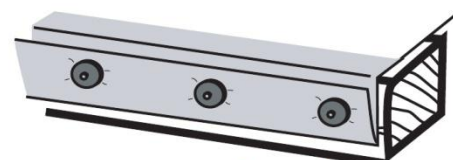

Dobre as lonas antes de pregá-las

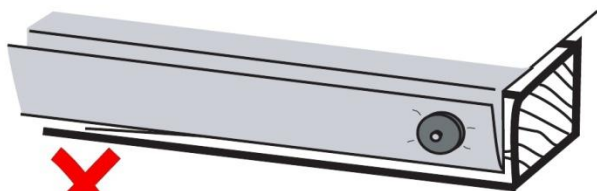

Não use apenas um ou dos pregos

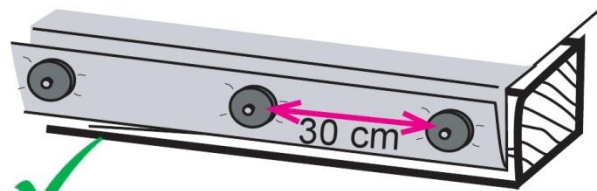

Use muitos pregos, com distância máxima de 30 cm

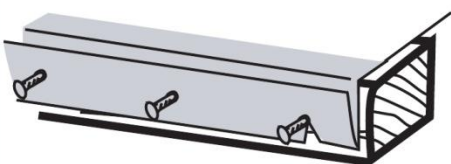

Não use prego sozinho para fixar a lona

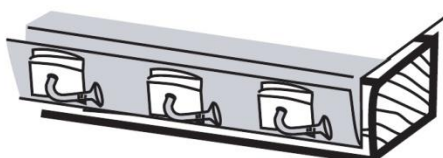

Pone os pregos através de corda, tampas de garrafa ou pedaços de plástico dobrados

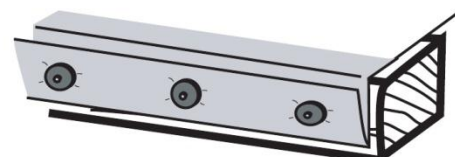

Porcas de metal ou pregos de chapa são fortes