

## EXCAVATION

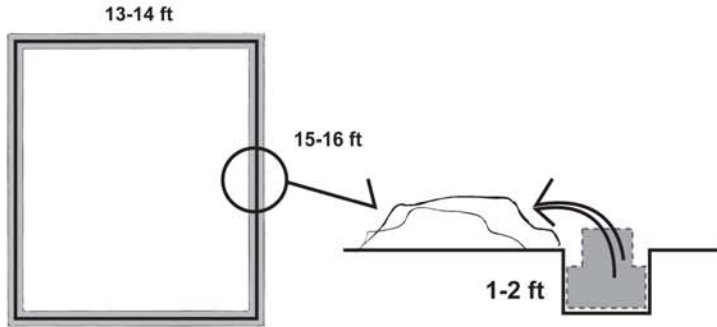

## STABLE FOOTING

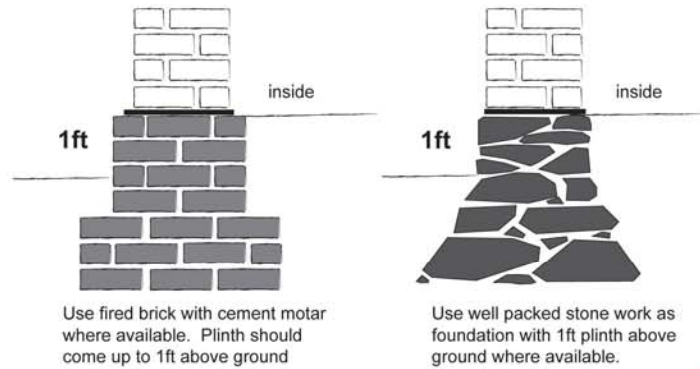

## PROTECTION AT GROUND LEVEL

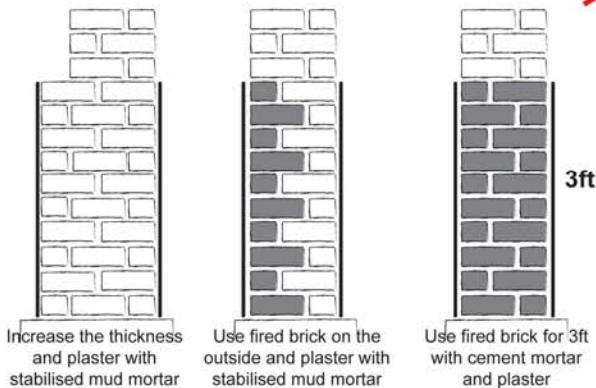

## ROOF SUPPORT

Do not place girders over openings in the wall. Ensure that load of the girder is spread out by adding a piece of timber 2-3ft long underneath.

Waterproof membrane help protects the roof.

A small slope is required to drain water away.

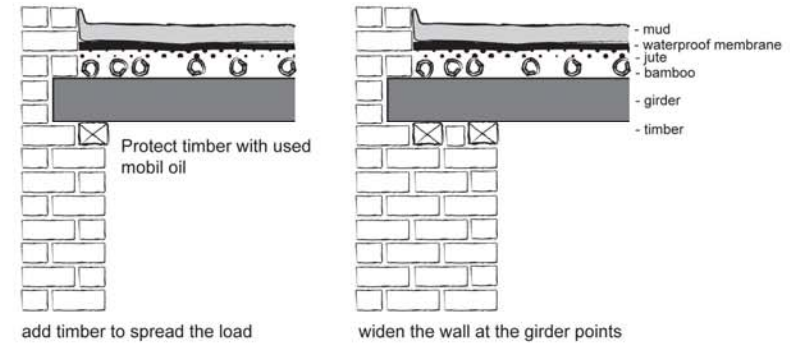

openings should not be too close to corners - at least 1ft away.

lintels should be at least 1ft wider than the opening on both sides

One finger of mortar between all surfaces of bricks makes equal spacing and avoid vertical crack line

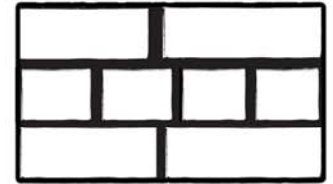

## WATERPROOFING

Apply Damp Proof Course (DPC) 1ft above ground or above plinth to protect wall from rising ground water.

Plaster the walls inside and outside for 3ft above ground

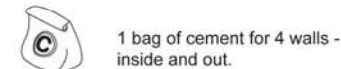

Bitumen plaster, stabilising mud with straw can also be used.

## PROTECT THE CORNERS

Increase thickness at corner, or make buttresses by overlapping the walls

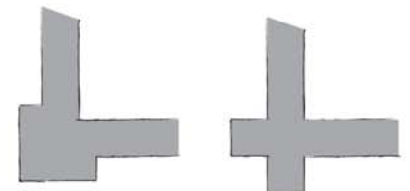

## EXCAVATION

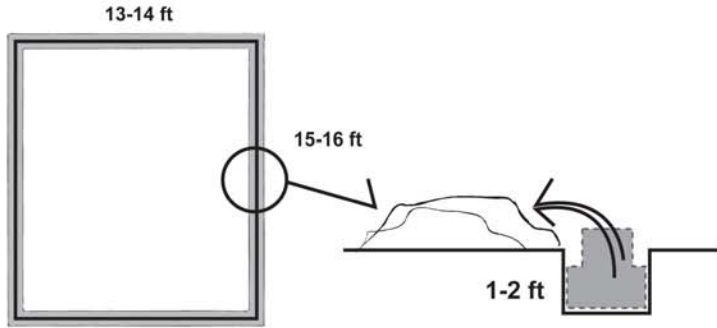

## STABLE FOOTING

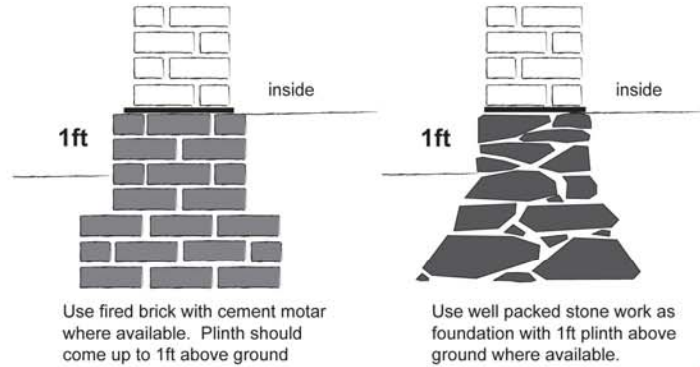

## PROTECTION AT GROUND LEVEL

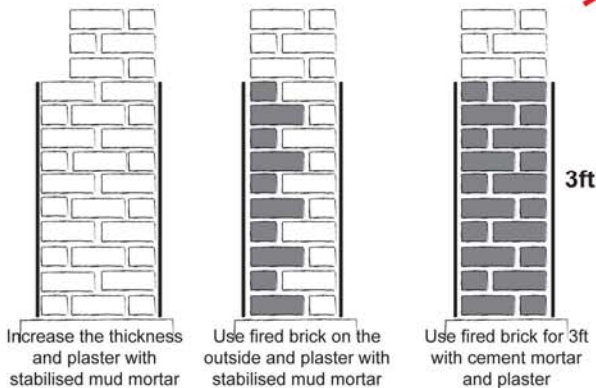

## ROOF SUPPORT

Do not place girders over openings in the wall. Ensure that load of the girder is spread out by adding a piece of timber 2-3ft long underneath.

Waterproof membrane help protects the roof.

A small slope is required to drain water away.

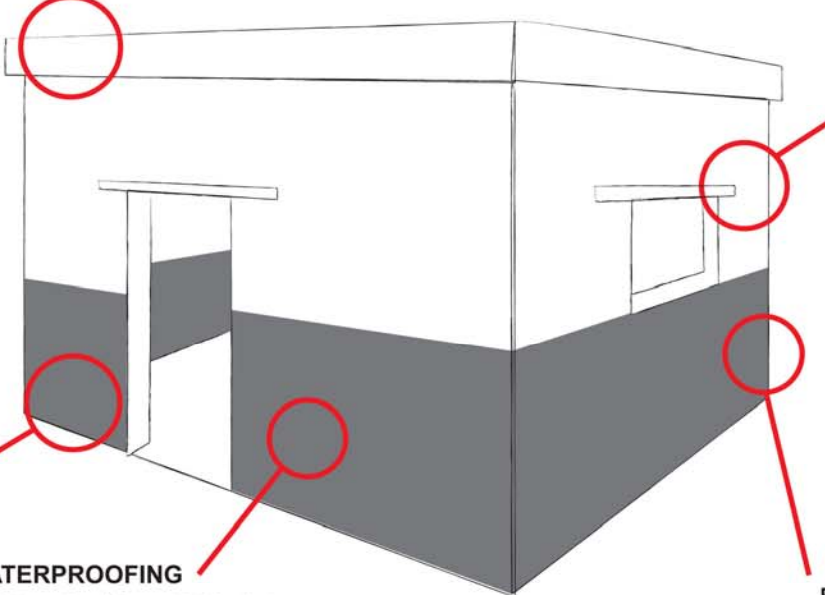
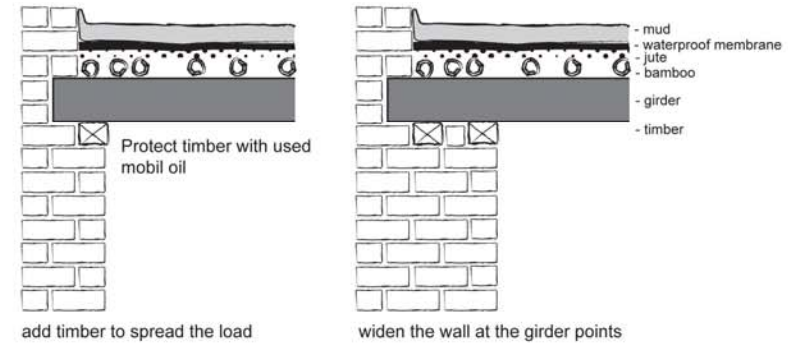

openings should not be too close to corners - at least 1ft away.

lintles should be at least 1ft wider than the opening on both sides

One finger of mortar between all surfaces of bricks makes equal spacing and avoid vertical crack line

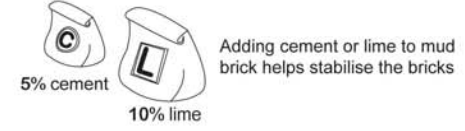
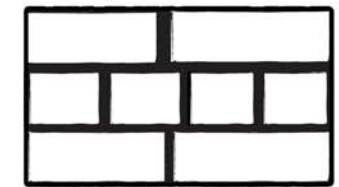

## WATERPROOFING

Apply Damp Proof Course (DPC) 1 ft above ground or above plinth to protect wall from rising ground water.

Plaster the walls inside and outside for 3ft above ground

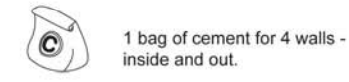

Bitumen plaster, stabilising mud with straw can also be used.

## PROTECT THE CORNERS

Increase thickness at corner, or make buttresses by overlapping the walls

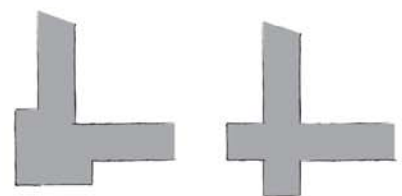

## EXCAVATION

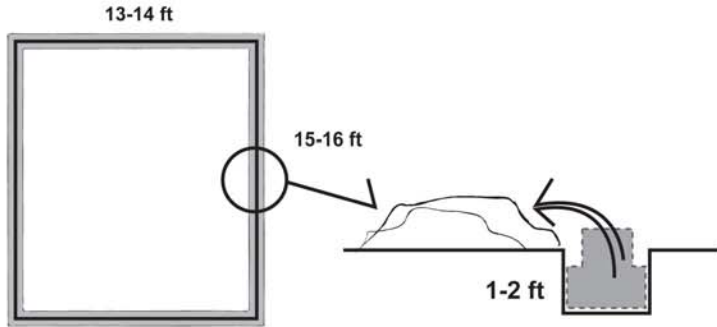

## STABLE FOOTING

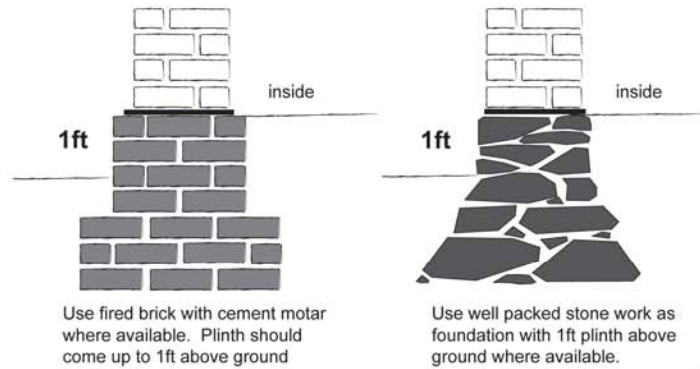

## PROTECTION AT GROUND LEVEL

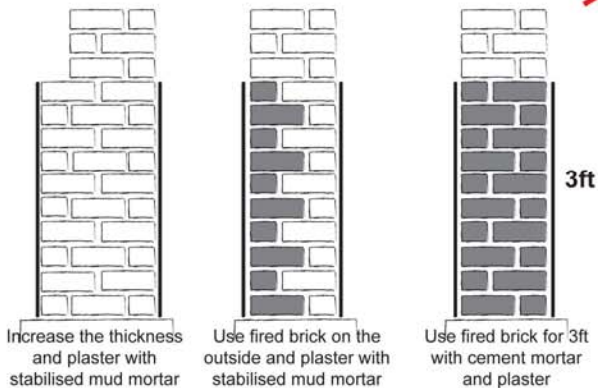

## ROOF SUPPORT

Do not place girders over openings in the wall. Ensure that load of the girder is spread out by adding a piece of timber 2-3ft long underneath.

Waterproof membrane help protects the roof.

A small slope is required to drain water away.

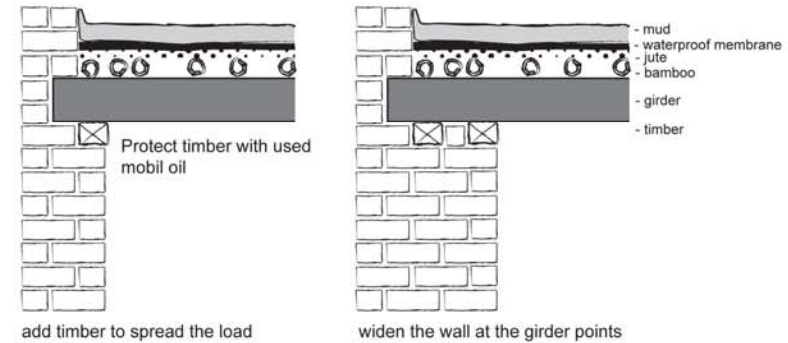

openings should not be too close to corners - at least 1ft away.

lintels should be at least 1ft wider than the opening on both sides

One finger of mortar between all surfaces of bricks makes equal spacing and avoid vertical crack line

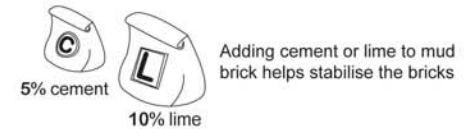
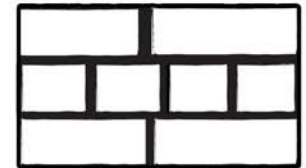

## WATERPROOFING

Apply Damp Proof Course (DPC) 1 ft above ground or above plinth to protect wall from rising ground water.

Plaster the walls inside and outside for 3ft above ground

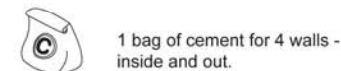

Bitumen plaster, stabilising mud with straw can also be used.

## PROTECT THE CORNERS

Increase thickness at corner, or make buttresses by overlapping the walls

