



CONSTRUCTION OF HOUSES WITH ACCESSIBILITY FACILITIES FOR PERSONS WITH DISABILITIES

Introduction

When constructing houses, it is important to design them with simple designs to enable persons with disability (PWDs) to have access to houses. These designs should be included at the start itself, so that no cost would be involved during the construction process. When design modifications are required they can be incorporated with very little cost. These simple but appropriate designs, such as disability friendly houses and toilets will help improve the mobility and accessibility of PWDs. Further, when common compounds, public places and play areas are constructed; consideration must be given to the accessibility for PWDs. Following are some useful and descriptions to keep in mind when constructing houses. Alternative designs can be used according to individual requirements.

Construction of a ramp

A ramp is constructed to enable wheel chair users to enter into a floor which is situated in a higher elevation. Further, the ramp can be accessed by persons with other disabilities, the aged, persons using prams etc.

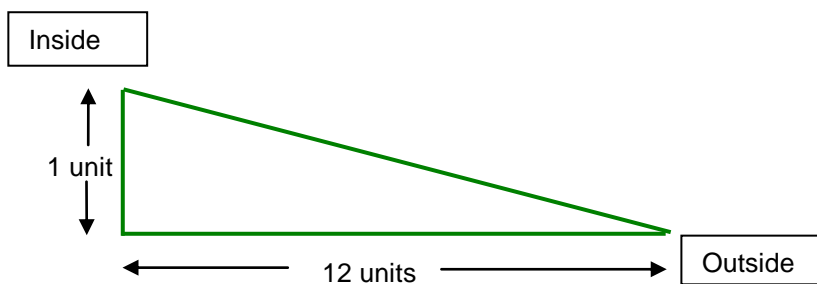

Construction of a ramp should consist of minimum 4'- 0" width (wide). It should consist of thick brick kerbs on both sides, preferably 9" in thickness (in cement and sand). The rubble foundation as shown in figure 1 should be constructed as 12" x 12" in depth using cement and sand 1:5.

The earth filling between the foundations should be compacted to the gradient. This should be covered by a layer of plain concrete of 1:3:6 - 1" and 2" thick layer to cover the earth filling maintaining the rough surface of 1:12 gradient. There should be 2' - 6' high galvanized (1 1/2" diameter) hand rails at both sides of the ramp fixed with 9"x9"x15" deep concrete (1:2:4-3/4") foundation at 3'-0" distances as shown in fig 2 - 4.

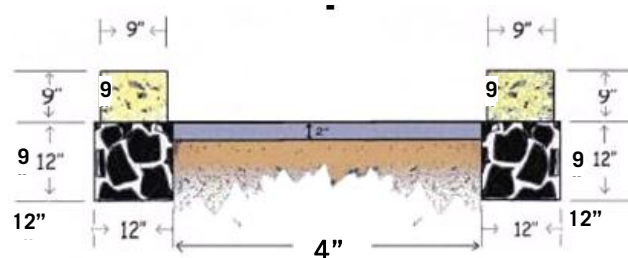

Figure 1: Cross section of the ramp
Consisting of 9" brick kerbs, including rubble foundation size 12" x 12", earth filling and compact in gap between both sides of the kerb and lay 2" thick plain concrete.

It is advisable to have one coat of anticorrosive paint and two coats of enamel paint on the handrails. (Please see the details in Figure 1 above).

The gap between both side kerbs should be filed with earth and compacted. Use 2" thick plain concrete on top. The top surface should be rough with a gradient of 1:12.

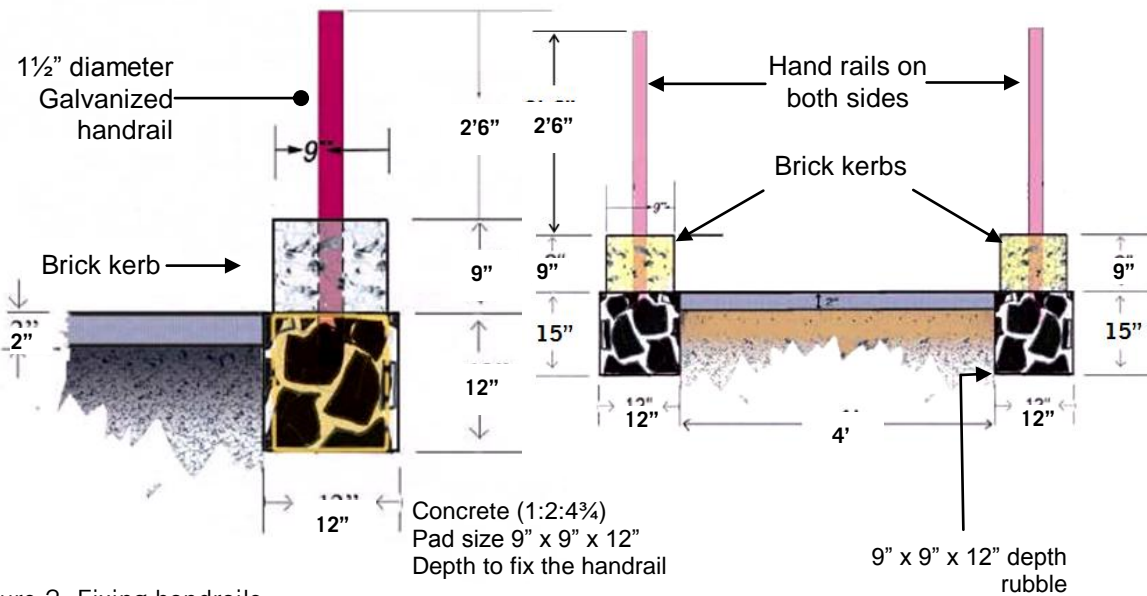

Figure 2: Fixing handrails

Figure 3: Cross section of the ramp with hand rails

Placing Handrails in the foundation

Figure 5 shows the view of a completed ramp way. If space is limited, part of the foundation can be used as support for the ramp. The guard rails can be fixed to this part of the foundation.

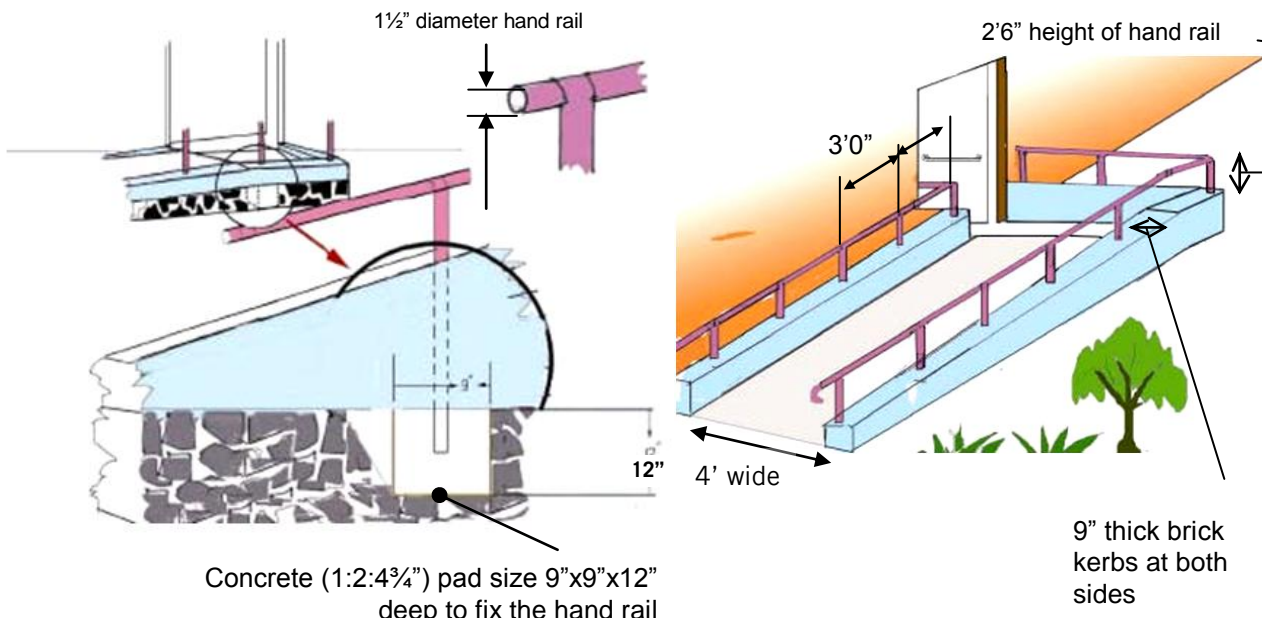

Figure 4: Placing handrails in the foundation

Figure 5: Completed ramp way

technical brief

Ramp constructed parallel to the plinth wall

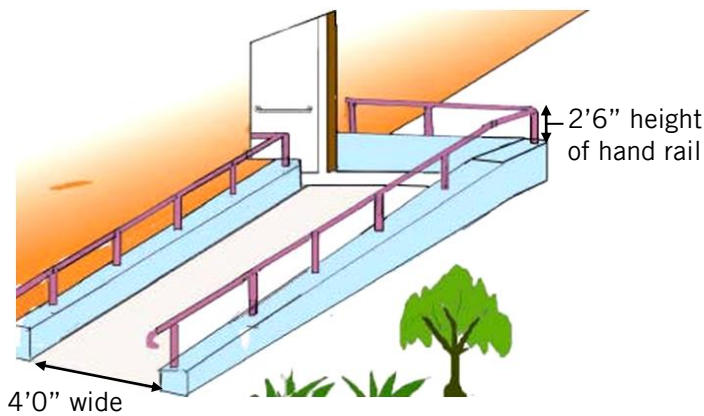

Figure 6.1: Type I ramp

This ramp should end at least 3 ft. away from the further side of the door opening to allow for a turning circle of minimum 3 ft. A turning circle of minimum of 3 ft. diameter should be allocated at the intersection of all corridors and walkways. (These are shown in fig. 6.1 & 6.2.)

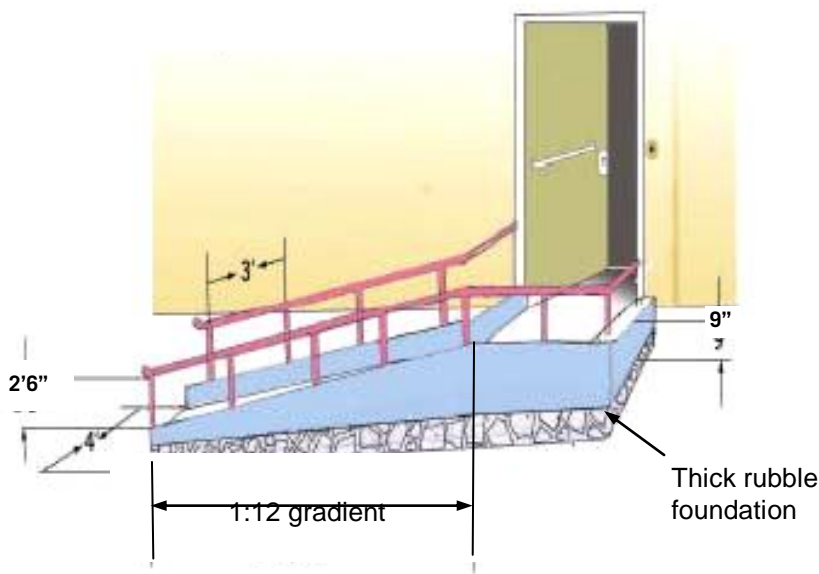
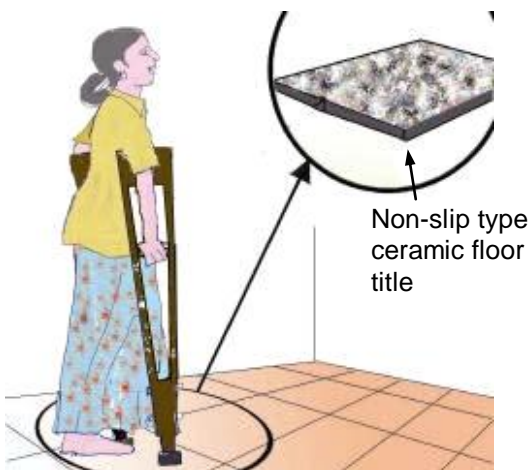

Figure 6.2: Type II ramp

Floor finishing



All surfaces of the floors should have a rough finish and the floor tiles used should not be slippery.

Figure 7: Flooring

technical brief

Construction of Wheel Chair accessible toilet

Construction of the toilet needs to be minimum of 5'-9x5'-9' in size and should consist of ceramic water closet (commode). There should be 1- 1/2" diameter-galvanized handrails fixed around the walls as per figure 8.

The minimum width of the door should be 3'-0" fixed to be opened from out of the toilet as shown in figure 12. All surfaces of the internal walls can be painted with two coats of emulsion paint.

Details of another type of handrail fixed around the commode is shown in Figure 9

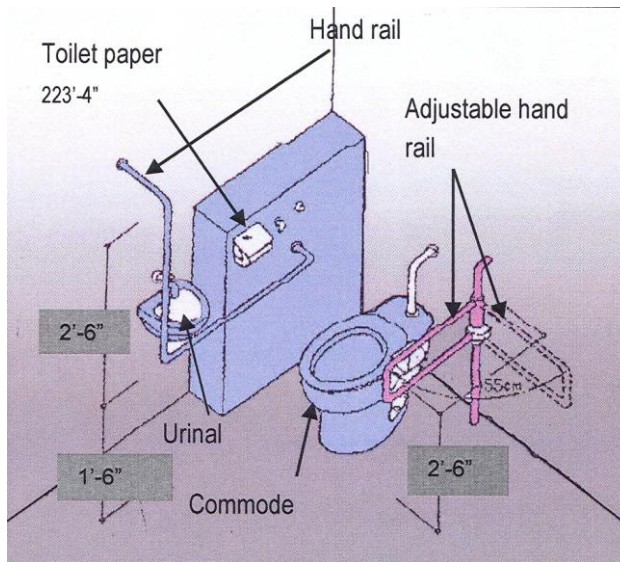

Figure 8: Wheelchair accessible toilet

Fixing a wash basin & mirror

The wash basin has to be fixed at the height of 2' -6" from the floor to enable wheel chair users for easy access. A hand rail should be fixed around the wash basin to help the user to get the grip.

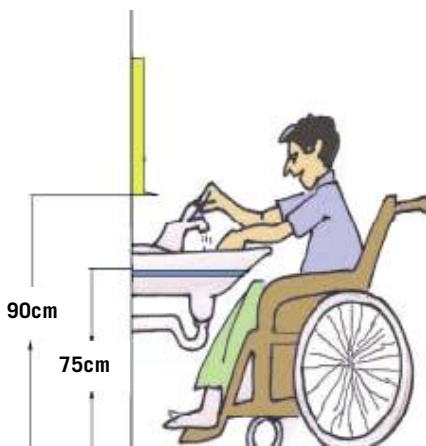

Figure 10: Fixed wash basin & mirror

The mirror should be fixed at 2"-9".

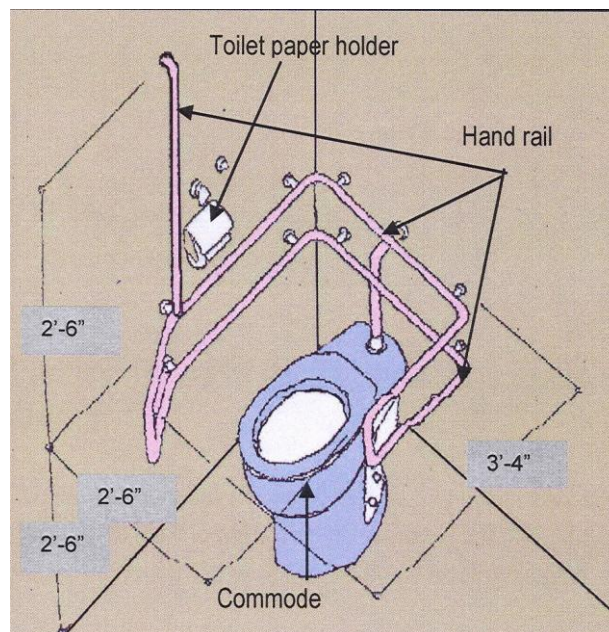
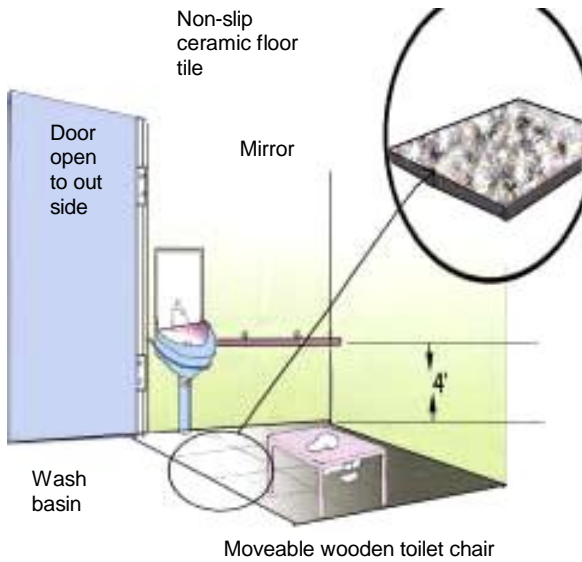

Figure 9: Wheelchair accessible toilet



Construction of toilet with ceramic squatting pan

A movable wooden toilet chair has to be placed ideally at the squatting pan to enable the user to sit. Non-slippery tiles should be used for the floor. A hand rail fixed to the wall around the toilet as shown in figure 11 is necessary to help the user move comfortably.

Figure 11: Toilet

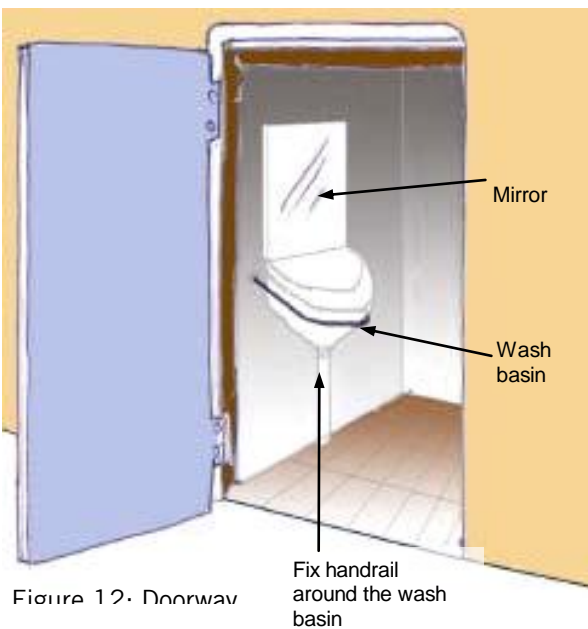

Construction of doorways

Figure 12 shows how to fix a wash basin with hand rails at the height of 2' -6". The figure also shows how the door is fixed, so that it can be opened to outside.

Door size 3'-0" x 6'-0" high to open at outside of the toilet.

Figure 12: Doorway

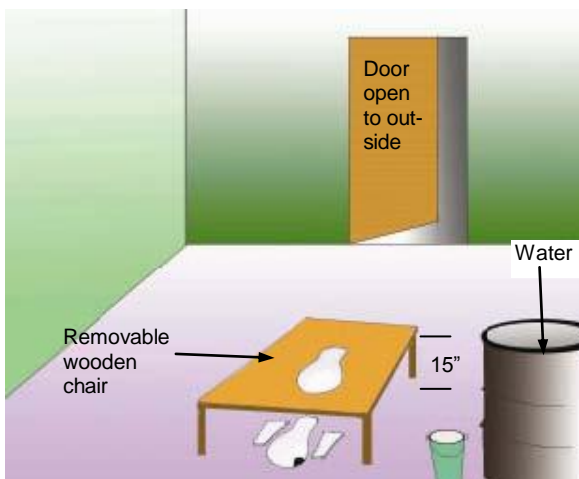

Construction of an economical toilet for use by persons with disabilities

The toilet shown in figure 13.1 is designed with hand rails for support and safety purposes of the users. A barrel of water is kept by the side of the movable wooden chair in areas where there is no access to pipe water.

Figure 13.1: Economical toilet

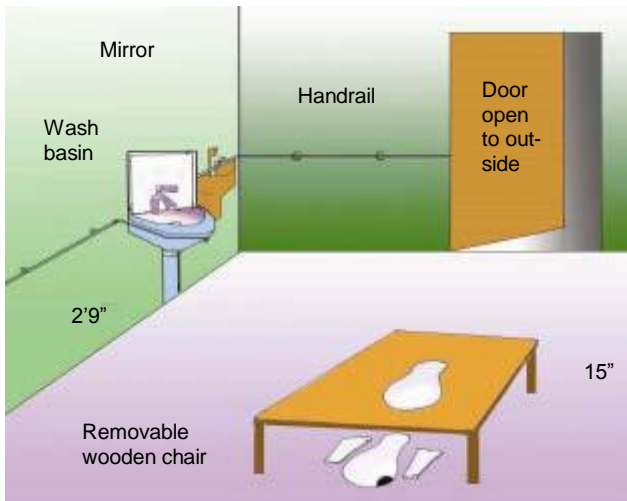
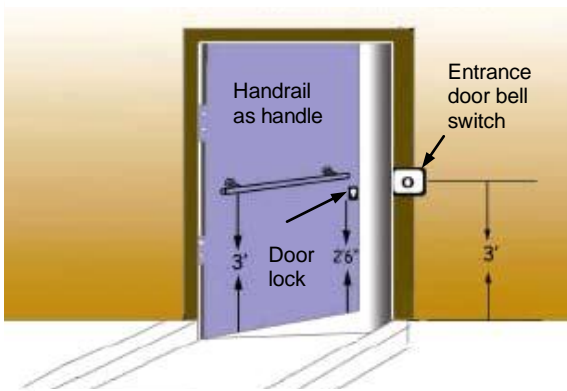

Figure 13 2: Toilet with washbasin and mirror

Construction of doorways

Bell, switch, door handle and lock



Fix bell switch at 3 feet high.

Figure 14: Doors and bell

All doors should be with internal sizes of not less than 6'-6"x3'-0" width to enable wheel chair users to move comfortably inside any house, so that it would enable any disabled persons to allow move independently as shown in Figure. 14. The bell, the hand rail, the switch, door handle and the lock should be fixed as shown in the same picture.

Fixing Windows



Fix a window at 3 feet high, inside of the room.

Figure 15: Windows

Window with a plain glass pane should be fixed at top hung, open to inside by the wheel chair user as shown in Figure.15.

Electric fixing of plugs, switches, bells, alarms

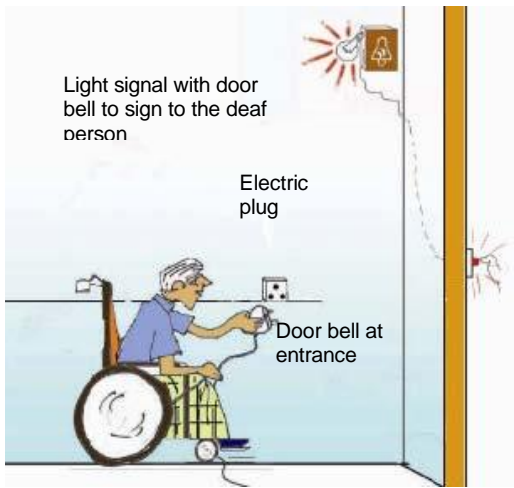

The door bell should be fixed at 3' in height with an electric bulb (next to the bell) to hear/see the bell ring. The electric plug base shown in Figure 16 has to be at 3' height.

Figure 16: Electrical plugs

Design of the kitchen area

Accessible kitchen cupboards

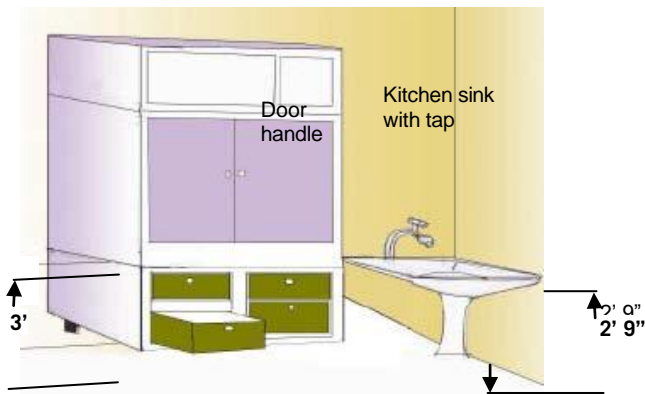

All pantry cupboards and sinks should be fixed at the given heights shown in Figure. 17.

Figure 17: Kitchen cupboards

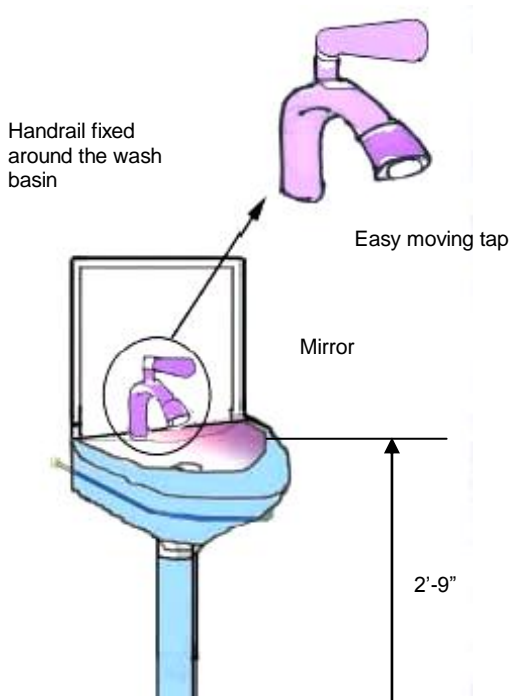

All taps at sinks and wash basins should be easily handled by all persons.

Figure 18: Sink and taps

technical brief

Height of chairs

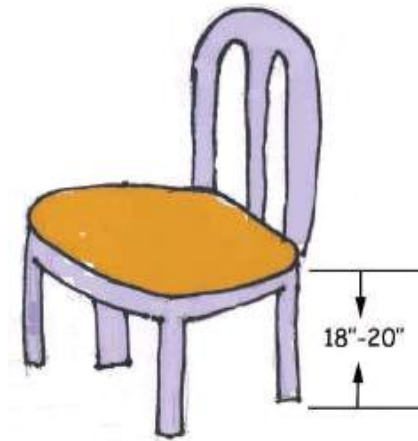

All chairs should be between 18"-20" as shown in Figure 19.1.

Figure 19.1: Rounded corners of a chair and the height of the seat level

Height of tables and other furniture and the finishing

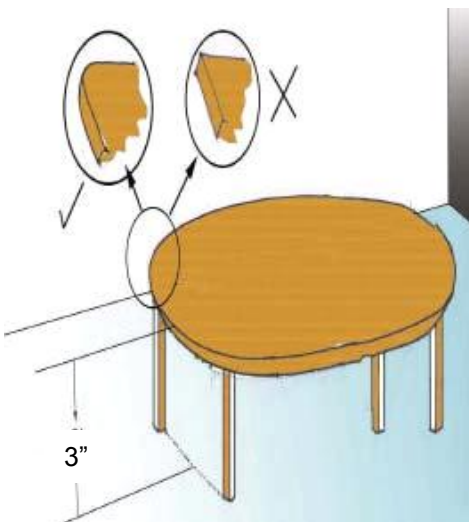

All tables should maintain a height of 2'- 9".

The edges

All edges of tables, stools and chairs should end with a rounded finish for safety purposes.

Figure 19.2: Rounded table

Bedroom furniture, calling bell/alarm

Top hang fixed window sash

The alarm bell should be next to the bed to help the user to call a caretaker. Also, it will also enable the caretaker to attend to the person at once.

There should be a vibrating pillow or alternative apparatus to help the deaf person to wake up.

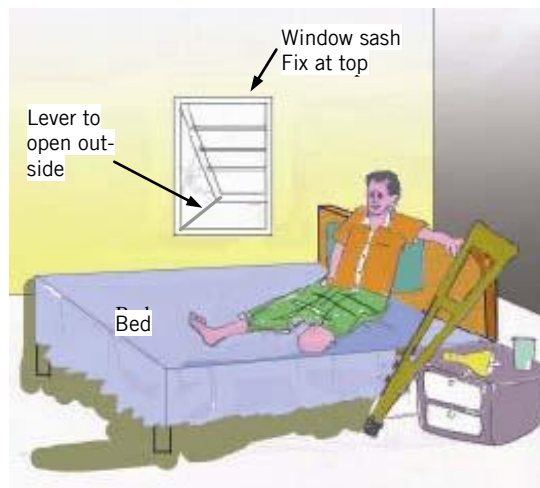

Figure 20: Bedroom furniture

technical brief

Construction of the road way in the housing scheme

The pathway inside the housing scheme needs to allow wheel chair users to move independently. Therefore, the road has to be constructed as follows;

- Cut and fill or fill and compact surfaces to maintain a level road of 10'-0" (width).
- Lay 2" thick metal and compact them using a 10 ton roller and apply hot tar afterwards. This should be followed by spreading sand or metal chips on the tar road to complete the road in the housing scheme.
- There should be kerb cuts at all entrances of the houses so that wheel chairs can move independently.

Practical Action, South Asia
5, Lionel Edirisinghe Mawatha
Colombo 5
Sri Lanka
Tel: +94 (11) 2829412
Fax: +94 (11) 2856188
E-mail: janathakshan@practicalaction.org.lk
Web: www.janathakshan.net

Practical Action
The Schumacher Centre
Bourton-on-Dunsmore
Rugby, Warwickshire, CV23 9QZ
United Kingdom
Tel: +44 (0)1926 634400
Fax: +44 (0)1926 634401
E-mail: inforserv@practicalaction.org.uk
Website: <http://practicalaction.org/practicalanswers/>

Practical Action is a development charity with a difference. We know the simplest ideas can have the most profound, life-changing effect on poor people across the world. For over 40 years, we have been working closely with some of the world's poorest people - using simple technology to fight poverty and transform their lives for the better. We currently work in 15 countries in Africa, South Asia and Latin America.

technical brief